

# THE JOINT TEAM



**U.S. AIR FORCE**



Airmen,

Today, we find ourselves in an era of strategic competition against adversaries who seek to outpace and eventually overtake us. They are building and refining their military capabilities while simultaneously seeking to disrupt the rules-based international order. The future challenging and uncertain environment requires an adaptive, innovative, and ready force that can effectively operate with any and all Services. The importance of having a capable and lethal Joint Force cannot be overstated.

To that end, every Airman needs to know what is at stake in strategic competition and to understand the critical importance of synchronizing our capabilities. Throughout our careers, we have seen the capabilities of our joint partners and how they amplify our own strength and power. As technology and information change at a rapid pace, the persistence of our Airmen, Guardians, Soldiers, Sailors, Marines, and Coast Guardsmen to innovate and solve complex problems is imperative to winning against those who challenge our way of life.

Each of us is part of a larger team, bringing our individual talents to add value to a cause much bigger than ourselves. We must all stay rooted in the conceptual knowledge of the Joint Force and what each service member brings to the fight. Likewise, we must recognize the operational importance of airpower and apply it across the full spectrum of warfare.

This guide provides us the knowledge of the Joint Force and outlines expectations for us all to know, articulate, and implement across the Air Force. Understanding the value each service brings to the fight is paramount when it comes to competing, deterring, and winning the high-end fight. Employing the concepts in this “Purple Book” is the first step toward a unity of effort that will allow us to develop the military our nation needs and to ensure the capabilities we bring to the fight – together – will always be unmatched!

Aim High!

A handwritten signature in black ink, appearing to read 'JoAnne S. Bass'.

**JoAnne S. Bass**  
**Chief Master Sergeant of the Air Force**

A handwritten signature in black ink, appearing to read 'Charles Q. Brown, Jr.'.

**Charles Q. Brown, Jr.**  
**General, USAF**  
**Chief of Staff**

## PURPOSE

---

Since 1947, The United States Air Force has been a critical component of every conflict, humanitarian mission, and military presence around the globe. Every Airman contributes to the delivery of sovereignty and freedom through their specialized skillset, thereby generating airpower—anytime, anywhere. To continue to advance with the speed and agility required to keep pace in a dynamic and competitive environment, our Joint Force provides capabilities that validate the strength of the United States, its allies, and its partners. In order for our Soldiers, Marines, Sailors, Airmen, Guardians, and Coast Guardsmen to deter our adversaries and respond to threats in any environment, we must understand, articulate, and demonstrate jointness.

This guide explains our Joint Force. It is built upon the foundation of contextual knowledge of joint doctrine, the National Defense Strategy, and the National Military Strategy. It clarifies the fundamental questions all Airmen must be able to answer: “How do I fit into the Joint Force, and how can I ensure I hone and deliver my unique capabilities to assure its success?” This guide will help Airmen internalize what it means to fight jointly, understand the missions of the Joint Force, appreciate the joint organizations that are leading the fight, comprehend how to integrate in a joint warfighting environment, and identify how the Air Force fits into the joint construct.

Leaders within the Department of Defense continue to stress the importance of every service member building an understanding of the emerging dangers that face our Nation. All warfighters must acknowledge the threat that our adversaries pose as they attempt to close the gap that presently exists between their capabilities and our own. That can never happen. Our Joint Force is comprised of professional, agile, and, adaptable men and women who serve with the highest level of integrity and commitment to their service, the Joint Force, and our Nation.

Information presented within this guide is intended to help Airmen understand the Joint Force. It is also meant to inform joint partners of the capabilities and knowledge that Airmen bring to their Joint Force formations. There are no previous versions of this guide.

---

# THE JOINT TEAM

## Table of Contents

---

<b>Chapter 1 - WHY WE FIGHT JOINTLY .....</b>	<b>5</b>
JOINTNESS .....	5
HISTORICAL AND LEGAL CONTEXT .....	6
<b>Chapter 2 - WHAT IS THE JOINT MISSION .....</b>	<b>8</b>
INSTRUMENTS OF NATIONAL POWER .....	8
THE COMPETITION CONTINUUM .....	9
MILITARY ACTIVITIES .....	10
SERVICE MISSIONS AND IDENTITIES .....	11
<b>Chapter 3 - WHAT ARE JOINT ORGANIZATIONS .....</b>	<b>13</b>
JOINT STAFF .....	13
COMBATANT COMMANDS .....	15
JOINT COMPONENT COMMANDS AND JOINT TASK FORCES .....	18
DEFENSE AGENCIES AND DOD FIELD ACTIVITIES .....	20
ALLIANCES AND PARTNERSHIPS .....	22
<b>Chapter 4 - WHAT IS JOINT WARFIGHTING .....</b>	<b>24</b>
JOINT OPERATIONS OVERVIEW .....	24
PRINCIPLES OF JOINT OPERATIONS .....	25
JOINT FUNCTIONS .....	27
THE JOINT SERVICE MEMBER .....	28
CODE OF CONDUCT FOR MEMBERS OF THE U.S. ARMED FORCES .....	29
<b>Chapter 5 - HOW THE AIR FORCE FITS INTO THE JOINT FIGHT .....</b>	<b>31</b>
AIR FORCE FUNCTIONS .....	31
AIR FORCE CORE MISSIONS .....	32
JOINT OPERATIONS ACROSS ALL DOMAINS .....	34
<b>CONCLUSION .....</b>	<b>35</b>
<b>UNITED STATES MILITARY RANKS .....</b>	<b>35</b>
<b>REFERENCES .....</b>	<b>35</b>

## Chapter 1 - WHY WE FIGHT JOINTLY

### JOINTNESS

The term “jointness,” as defined in Joint Publication (JP) 1, Doctrine for the Armed Forces of the United States, implies the cross-service combination wherein the capability of the Joint Force is understood to be synergistic, with the sum greater than its parts (the capabilities of the individual components). The Joint Force is a values-based organization. The character, professionalism, and values of service members across the Joint Force are vital for operational success.

The nature of the challenges facing the United States and its interests demand that the Armed Forces operate as a closely integrated joint team. This joint construct leverages the unique capabilities and characteristics of the Army, Marine Corps, Navy, Air Force, Space Force, Coast Guard, and National Guard to enhance operational effectiveness. Each service possesses distinct capabilities and roles as well as rich culture and tradition, which, when blended appropriately, serve to achieve unique operational objectives across the range of military operations.

Jointness also requires effective coordination with interagency and multinational partners. Using a whole of government approach is essential to advancing our interests to strengthen security relationships and capacity by, with, and through military forces of partner nations, U.S. and foreign government agencies, state and local governments, and intergovernmental and nongovernmental organizations. To succeed, the Armed Forces must refine and proportionally integrate the military with all the tools of American power while working with partner nations to do the same.

Effective integration of joint forces is intended to address geographic and functional vulnerabilities. This does not mean that all forces are represented equally in all operations. Rather, Joint Force Commanders (JFC) choose the capabilities they need from the forces at their disposal. Each service contributes distinct capabilities to the Joint Force; however, overall joint effectiveness is dependent on each service’s purposeful reliance on the other services’ capabilities to maximize complementary and reinforcing effects. The degree of interdependence varies based on operational needs and objectives. Jointness has become the fundamental organizing construct across all echelons. When the United States military operates as a cohesive team, its capabilities exceed those of individual components. Jointness is a force multiplier that empowers the United States military to defeat adversaries and dominate all domains of warfare (air, land, maritime, space, cyberspace, and information warfare) during competition, crisis, and conflict.

**For more information:** [JP 1, Doctrine for the Armed Forces of the United States](#)

- [https://www.jcs.mil/Portals/36/Documents/Doctrine/pubs/jp1\\_ch1.pdf](https://www.jcs.mil/Portals/36/Documents/Doctrine/pubs/jp1_ch1.pdf)

*“We must never fight another war the way we fought the last two. I have a feeling that if the Army and Navy had fought our enemies as hard as they fought each other, the war would have ended much earlier.”*

**President Harry S. Truman**  
**33rd President of the United States**



## **HISTORICAL AND LEGAL CONTEXT**

**National Security Act of 1947.** Prior to 1947, the United States military consisted of two distinct organizations in a fragmented structure – the Department of War and the Department of the Navy. On July 26, 1947, President Harry S. Truman executed a major restructuring of military forces by signing the National Security Act of 1947 into law. The National Security Act merged the Department of the Army (formerly the Department of War), the Department of the Navy, and the newly established Department of the Air Force into a single Department of Defense (DoD) under the Secretary of Defense (SecDef). The purpose of the reorganization was to integrate the policies and procedures of all military departments and to provide for their unified direction under civilian control of the SecDef, but not to merge the departments of the services. It also established Unified Combatant Commands to provide strategic direction of combatant forces and their integration into an efficient team of land, naval, and air forces. In addition to restructuring the U.S. military, the National Security Act of 1947 established the Central Intelligence Agency and the National Security Council (NSC). These organizations serve to assist Presidents in forming and implementing foreign policy.

**For more information:** [National Security Act of 1947](#)

- <https://history.state.gov/milestones/1945-1952/national-security-act>

**Department of Defense Reorganization Act of 1958.** Just more than a decade after the enactment of the National Security Act of 1947 and the subsequent merging of the military departments into a single DoD, the services still made overlapping efforts, requiring further policy intervention to increase joint interoperability. Thus, the Department of Defense Reorganization Act of 1958 was signed into law by President Dwight D. Eisenhower on August 6, 1958, building upon the efforts of the previous law. The Reorganization Act streamlined channels of authority, limiting service responsibilities and empowering the combatant commands in the employment of combat forces. Additionally, it authorized the President, acting through the SecDef, to establish unified or specified commands, assign missions, and determine their structure. It established a clear line of command from the President, through the SecDef, to combatant commanders. President Eisenhower’s goal was “a complete unification of all military planning and combat forces and commands.” The law requires that each service maintain a responsibility to organize, train, and equip forces under the direction of their respective service secretary. When a crisis requires a military response, authority is granted to combatant commanders to direct, deploy, or mobilize assigned forces provided by each service component.

**For more information:** [Department of Defense Reorganization Act of 1958](#)

- <https://www.govinfo.gov/content/pkg/STATUTE-72/pdf/STATUTE-72-Pg514.pdf>

**Goldwater Nichols Act of 1986.** In April 1980, President Jimmy Carter authorized OPERATION EAGLE CLAW to rescue 53 American hostages in Tehran, Iran. The operation included assets from all military services—Army, Navy, Air Force, and Marines. According to the operations plan, Navy RH-53 helicopters were to launch from the aircraft carrier, USS Nimitz, headed for a remote site known as Desert One. Meanwhile, Air Force MC-130s and EC-130s would transport a 118-man assault force comprised of Army Rangers, Delta Operators, and Air Force Combat Controllers to Desert One where they would rendezvous and refuel the helicopters. From there, the assault force was to enter the U.S. Embassy compound in Tehran, rescue the hostages, and transport them to safety aboard Air Force C-141 aircraft. Despite the bravery and dedication of all involved, the operation was ultimately a failure and resulted in the loss of eight service members. As a result, retired Admiral James L. Holloway III led an official investigation into the operation’s failure and recorded the findings in the “The Holloway Commission Report.” The report highlighted 23 key findings; among them were deficiencies in command and control, joint training, and alterations to joint task force composition.

The lessons learned during OPERATION EAGLE CLAW prompted U.S. military and civilian leaders to pursue new legislation to codify joint organizing, training, and operating procedures. In October 1986, President Ronald W. Regan signed the Goldwater-Nichols Department of Defense Reorganization Act, sponsored by Senator Barry Goldwater and Representative Bill Nichols. The Goldwater-Nichols Act empowered the Chairman of the Joint Chiefs of Staff (CJCS) with greater influence, increased the authority of unified combatant commands, and enriched the Joint Staff by mandating that officers must have at least one joint tour for promotion eligibility to general or flag officer ranks (generals or admirals). Additionally, the Goldwater-Nichols Act established United States Special Operations Command to execute specialized, joint operations.

**For more information:** [H.R.3622 - Goldwater-Nichols Department of Defense Reorganization Act of 1986](#)

- <https://www.congress.gov/bill/99th-congress/house-bill/3622>

**OPERATION INHERENT RESOLVE.** Since the passage of the Goldwater-Nichols Act, the military services have planned and executed successful joint operations across the globe. For example, in response to the attacks on American soil on September 11, 2001, the joint team has conducted operations to defend the sovereignty of the U.S., destroy terrorist networks in Iraq and Afghanistan, and stabilize governments during threats of insurgency. Fighting alongside and in support of joint service partners, Airmen have secured forward operating bases, cleared roadways of improvised explosive devices, conducted airstrikes, and provided countless other capabilities to bring American military might to bear on U.S. adversaries.

The successful campaign against Islamic State of Iraq and Syria (ISIS) is one of many examples of the effectiveness of intentional Joint Force integration. This operation seamlessly integrated the capabilities of multiple services and allied nations. Combined Joint Task Force – Operation Inherent Resolve (CJTF-OIR) was established in 2014 to eliminate ISIS and ensure peace and stability for the people of Iraq and Syria. Throughout the nearly five years of operations, CJTF-OIR conducted over 34,000 airstrikes, 39,970 airlift sorties, and 331,454 aerial refueling missions. Remotely piloted aircraft provided support to partner forces and conducted Intelligence, Surveillance, and Reconnaissance missions throughout the area of responsibility. The Command and Control capabilities Airmen provided increased situational awareness and aircraft deconfliction and helped fuse battlefield information for distribution to the Joint Force.

By March 2019, ISIS had suffered a crippling defeat, losing all the territory they once held. In addition to the territorial defeat, ISIS's leadership degraded, and its ideology became widely condemned. Following ISIS's defeat, CJTF-OIR continued operations with a revised mission to advise, assist, and enable partner forces until they can independently defeat Daesh in designated areas of Iraq and Syria in order to set conditions for long-term security cooperation frameworks. The heroic efforts of United States Airmen, their joint service counterparts, and partner nation allies led to the liberation of more than 42,000 square miles and almost eight million people who had been under ISIS's oppressive control.

## Chapter 2 - WHAT IS THE JOINT MISSION

### INSTRUMENTS OF NATIONAL POWER

The United States' vital national interests have endured since the founding of our Nation. Vital interests represent the matters and ideals for which the Nation is willing to sacrifice and are considered necessary for America's survival. America's core vital interests include security of the homeland, safety of Americans at home and abroad, economic prosperity, and preservation of the American way of life.

As the global security landscape evolves, U.S. Presidents emphasize broad objectives in the National Security Strategy (NSS) to address enduring and emerging threats that endanger these interests. Subsequently, U.S. government departments and agencies build their own strategies to translate and refine the NSS into more detailed guidance for their individual organizations. To advance national interests, appropriate government officials, often with National Security Council direction, employ the instruments of national power to achieve strategic objectives. These instruments include diplomatic, informational, military, economic, financial, intelligence, and law enforcement (DIME-FIL) activities. Each instrument of national power works most effectively when it is supported by and operates harmoniously with the other elements. Accordingly, all departments and agencies work within their unique lanes to support the President's foundational strategy via what is often referred to as a whole of government approach.

- ★ **Diplomatic.** Diplomacy is the principal instrument for engagement with other states and foreign groups to advance U.S. values, interests, and objectives and to solicit foreign support for U.S. military operations.
- ★ **Information.** Every DoD action that is planned or executed, every word that is written or spoken, and every image that is displayed or relayed communicates the intent of DoD and, by extension, the U.S. government, to achieve strategic effects.
- ★ **Military.** The U.S. employs the military at home and abroad in support of its national security goals. While the ultimate purpose of the U.S. Armed Forces is to fight and win the Nation's wars, military activities also include capacity and capability building of partner militaries and humanitarian aid and assistance operations.
- ★ **Economic.** A strong economy with free access to global markets and resources is fundamental to general welfare, the enabler of a strong national defense. The Department of Treasury works with other U.S. Government agencies, governments of other nations, and international finance institutions to encourage economic growth and prevent economic or financial crises.
- ★ **Financial.** The U.S. Government utilizes an array of resources to deny access to specified individuals or groups, including states and non-state actors, from formal or informal financial systems, networks, or sources of funding. Some of these resources include foreign aid, trade agreements, tariffs, embargos, and economic sanctions.
- ★ **Intelligence.** Intelligence consists of data collected by various organizations through a variety of mediums. Ambiguous data is translated into coherent information about the environment, future capabilities and intentions, and relevant actors to provide advantage to decision makers, including commanders and policy makers.
- ★ **Law Enforcement.** The U.S. Government enforces laws through government agencies, intergovernmental organizations, and host-nation partners. Law enforcement enables the U.S.



Government to secure the homeland, detain criminals, and assist mission partners with security needs.

The United States leverages DIME-FIL activities in both proactive and retaliatory forms to shape behaviors and outcomes of foreign nations and situations. Proactively applied, DIME-FIL instruments ensure U.S. investment in critical relationships with like-minded foreign allies and partners. Conversely, retaliatory application of the instruments of national power is crucial to preventing aggression of bad actors that threaten the United States and its partners. The first Gulf War is one example of the U.S. Government’s employment of the instruments of national power to achieve strategic effects. When Saddam Hussein’s forces invaded Kuwait, President George H. W. Bush utilized diplomacy to energize a coalition of nations to develop specific rules of engagement for the counter operation. Through diplomacy and measured military action, the coalition successfully removed Iraqi forces from Kuwait while minimizing casualties.

**For more information:** [\*The First Gulf War; JP 1, Doctrine for the Armed Forces of the United States\*](#)

- <https://history.state.gov/departmenthistory/short-history/firstgulf>
- [https://www.jcs.mil/Portals/36/Documents/Doctrine/pubs/jp1\\_ch1.pdf](https://www.jcs.mil/Portals/36/Documents/Doctrine/pubs/jp1_ch1.pdf)

## THE COMPETITION CONTINUUM

The U.S. military’s mission extends beyond waging war on adversaries. The military plays an integral role in all aspects of DIME-FIL and provides a credible threat of force that empowers and enables our elected civilian leaders to leverage all instruments of national power to achieve objectives in accordance with national interests and policies.

Competition is a fundamental aspect of international relations. As state and non-state actors seek to protect and advance their interests, they continually compete over incompatible aims. The competition continuum describes a world of enduring competition conducted through a mixture of cooperation, competition, and armed conflict. These descriptors refer to the relationship between the United States and another strategic actor concerning a set of policy objectives. This description allows for simultaneous interaction with the same strategic actor at different points along the competition continuum.

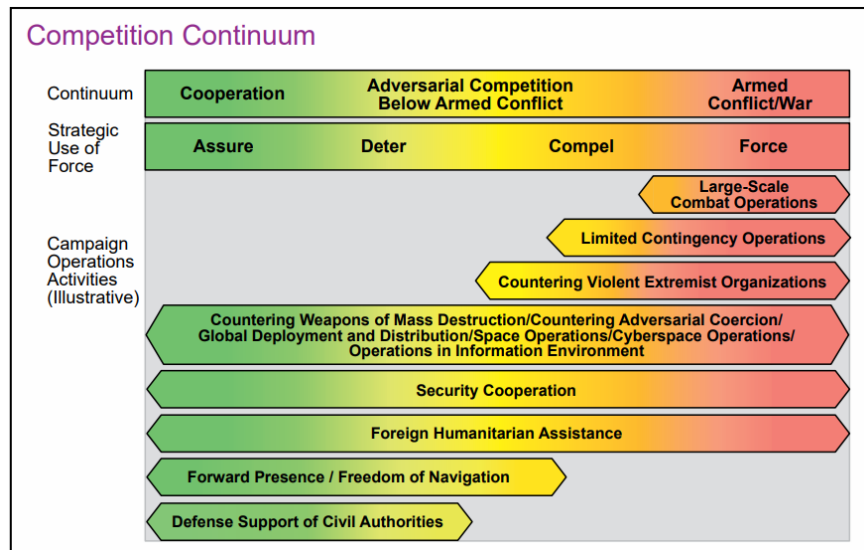

For instance, the United States might be in a state of competition with a strategic competitor regarding some interests, such as freedom of navigation in disputed areas, and cooperation in others, such as counter-piracy. By providing a lexicon to describe this complexity, the competition continuum facilitates shared understanding, both within the DoD and with interagency partners who often have a leading role. The elements of the competition continuum include:

- ✦ **Cooperation:** Situations in which joint forces take actions with another strategic partner in pursuit of policy objectives. Cooperation does not preclude some element of competition or even armed conflict when their objectives are not in complete alignment.
- ✦ **Competition:** Competition is when joint forces or multinational forces take actions outside of

armed conflict against a state or non-state adversary in pursuit of policy objectives, but neither seeks armed conflict. These actions are typically nonviolent and conducted under greater legal or policy constraints than in armed conflict but can include lethal and nonlethal actions by the joint force or sponsorship of surrogates or partners. Competition does not preclude some cooperation in other areas.

- ★ **Armed Conflict/War:** Armed conflict/war occurs when military forces take actions against an enemy in hostilities or declared war. International law distinguishes armed conflict from disturbances, including riots and protests, by the intensity of the conflict and the organization of the parties.

**For more information:** [JP 3-0, Joint Campaigns and Operations](#)

- [https://jdeis.js.mil/jdeis/new\\_pubs/jp3\\_0.pdf](https://jdeis.js.mil/jdeis/new_pubs/jp3_0.pdf)

## MILITARY ACTIVITIES

The emerging strategic environment presents ever-increasing threats to the security and interest of our Nation across the range of the DIME-FIL domains. The character of war is not static, and the full spectrum of the instruments of national power are essential to deterrence and victory in future high-end fights with great power competitors. For its part, the Joint Force focuses on six primary activities in fulfilling its obligation to the Nation:

- ★ **Secure the Homeland.** Securing the U.S. homeland is the Nation's first priority. Defense of the homeland is the DoD's highest priority, aiming to identify and defeat threats as far away from the homeland as possible.
- ★ **Win the Nation's Wars.** Winning the Nation's wars remains the preeminent justification for maintaining capable and credible military forces in the event that deterrence should fail.
- ★ **Deter our Adversaries.** Deterring adversarial powers from making the decision to utilize armed force is one of the most vital tasks of national defense. Defending national interests requires the capability to prevail in conflict and deter potential adversaries that threaten the vital interests of the U.S. or its partners.
- ★ **Security Cooperation.** Security cooperation encompasses all DoD interactions with foreign defense establishments to build defense relationships that promote specific U.S. security interests, develop allied and friendly military capabilities for self-defense and multinational operations, and provide U.S. forces with peacetime and contingency access to host nations.
- ★ **Support to Civil Authorities.** The U.S. responds to a variety of civil crises to relieve human suffering and restore civil function. These crises may be foreign or domestic and may occur independently, as in a natural disaster disrupting an otherwise functioning society, or within the context of a conflict, such as widespread suffering in a nation embroiled in insurgency.
- ★ **Adapt to a Changing Environment.** The strategic security environment is constantly changing. Effectiveness in addressing an evolving environment and meeting unique security challenges requires appropriate employment of the instruments of national power and the capabilities of the joint team to conduct military operations worldwide. The Joint Force must be innovative and agile.

**For more information:** [JP 1, Doctrine for the Armed Forces of the United States](#)

- [https://www.jcs.mil/Portals/36/Documents/Doctrine/pubs/jp1\\_ch1.pdf](https://www.jcs.mil/Portals/36/Documents/Doctrine/pubs/jp1_ch1.pdf)

## SERVICE MISSIONS AND IDENTITIES

Each service maintains the responsibility to organize, train, and equip forces to conduct specific missions. Service members from each military branch are employed as a Joint Force to execute military operations under the direction of combatant commanders. Each service maintains its own organic mission, identity, culture, and values. When employed as a joint team, the services blend their unique elements to complement the strengths, capabilities, and values of the other services to achieve mission success.

**United States Air Force.** The Air Force's mission is *"To Fly, Fight, and Win...Airpower Anytime, Anywhere."* The Air Force mission statement reflects a commitment to achieve and maintain superiority across all domains through the application of airpower to gain a distinct advantage over our adversaries. The Air Force's identity is grounded in independence and ingenuity, and its culture emphasizes the term *Airman*. This term refers to anyone who understands and appreciates the full range of air and space capabilities and can employ or support some aspect of airpower. The Air Force core values include integrity, service before self, and excellence in all we do.



**United States Space Force.** The Space Force provides Guardians to conduct global space operations that enhance the way our joint and coalition forces fight, while also offering decision makers military options to achieve national objectives. Guardians comprise those forces that protect, defend, and project spacepower. They provide support, security, stability, and strategic effects by employing spacepower in, from, and to the space domain. The Space Force is a lean, mission-focused, digital service that relentlessly pursues new ideas, takes calculated risk, and rapidly learns from failure. Guardians value agility, innovation, and boldness.



**United States Army.** The Army's mission is to deploy, fight and win our Nation's wars by providing ready, prompt, and sustained land dominance by Army forces across the full spectrum of conflict as part of the Joint Force. The Army's mission is vital to the Nation as it propels the service capable of defeating enemy ground forces and indefinitely seizing and controlling adversary centers of gravity – its land, resources, and population. Army culture is founded on a fundamental belief in the human dimension of war and the centrality of land combat in its prosecution. Soldiers identify as warriors; accordingly, they value troop duty to the staff, training to education, and the practical to the theoretical. The Army core values include loyalty, duty, respect, selfless service, honor, integrity, and personal courage.

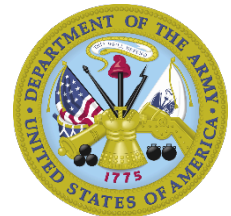

**United States Marine Corps.** The Marine Corps provides fleet marine forces of combined arms, together with supporting air components, for service with the fleet in the seizure or defense of advanced naval bases and for the conduct of such land operations as may be essential to the prosecution of a naval campaign. The culture of the Marine Corp is unique from that of the other services; Marines are proud to be "one of the few" and value being a Marine over any rank or occupational specialty. All Marines are riflemen first and selflessly take care of their own. The core values of the Marine Corps include honor, courage, and commitment.



**United States Navy.** The United States is a maritime Nation, and the Navy protects America at sea. The U.S. Navy defends freedom, preserves economic prosperity, and keeps the seas open and free. It remains prepared to execute its timeless role, as directed by Congress and the President, to defend American interests around the globe. Navy culture is a deployment culture, and Sailors pride themselves on the months and years they spend at sea. Accordingly, the Navy is the most independent of the services and prizes autonomy of command at sea and technical expertise. The Navy core values include honor, courage, and commitment.



**United States National Guard.** The National Guard has a unique dual mission that consists of both Federal and state roles. For state missions, the governor, through the state Adjutant General, commands Guard forces. The governor can call the National Guard into action during local or statewide emergencies, such as storms, fires, earthquakes, or civil disturbances. Additionally, the President of the United States can activate the National Guard for participation in federal missions. When federalized, Guard units are commanded by the combatant commander of the theater in which they are operating. The National Guard comprises the primary combat reserve of the Army and the Air Force, leveraging the civilian skillsets of its Soldiers and Airmen in a military capacity. Guardsmen prioritize readiness, people, and innovation.



**United States Coast Guard.** Organized under the U.S. Department of Homeland Security, the United States Coast Guard fulfills its mission to ensure our Nation's maritime safety, security, and stewardship. The Coast Guard saves those in peril and protects the Nation from all maritime threats. During times of war or conflict, the Coast Guard serves under the Department of the Navy. Its legal core is as a military service, vested with unique law enforcement authorities and leavened with a well-earned reputation for humanitarian service. These attributes enable Coast Guardsmen to satisfy a broad, multi-mission mandate to the Nation. The Coast Guard core values include honor, respect, and devotion to duty.



**For more information:** [\*The Noncommissioned Officer and Petty Officer, Spacepower\*](#)

- <https://www.jcs.mil/Portals/36/Documents/Doctrine/nco/NCO-Backbone.pdf>
- [https://www.spaceforce.mil/Portals/1/Space%20Capstone%20Publication\\_10%20Aug%202020.pdf](https://www.spaceforce.mil/Portals/1/Space%20Capstone%20Publication_10%20Aug%202020.pdf)

## Chapter 3 - WHAT ARE JOINT ORGANIZATIONS

Joint warfare is team warfare. The Armed Forces of the United States—all military organizations at all levels—are a team. The capacity of the Armed Forces to operate as a cohesive unit, in collaboration with governmental, non-governmental, civil, and public entities as well as international allies and partners, is a key advantage in any operational environment. The term “joint” connotes activities, operations, organizations, etc. in which elements of two or more military departments participate. The term “combined” identifies two or more forces or agencies of two or more allies operating together. Success depends on well-integrated command headquarters, supporting organizations, and forces that operate in concert with one another.

The Armed Forces of the United States are most effective when employed as a Joint Force. A Joint Force is defined as a force composed of elements, assigned or attached, of two or more military departments operating under a single Joint Force Commander (JFC). This comprehensive approach, involving all participating organizations, both military and nonmilitary, within an operational area requires the JFC to understand the capabilities, limitations, and mandates of those organizations involved and effectively communicate the mission of the Joint Force. The major components of the Joint Force include the Joint Staff, Combatant Commands (CCMD), Joint Task Forces (JTF), and Defense Agencies and DoD Field Activities (often referred to as 4th Estate Agencies). It is further bolstered by a powerful complement of international alliances and partnerships.

**For more information:** [\*DoD Dictionary of Military and Associated Terms\*](#)

- [https://jdeis.js.mil/jdeis/new\\_pubs/dictionary.pdf](https://jdeis.js.mil/jdeis/new_pubs/dictionary.pdf)

### JOINT STAFF

**The Joint Chiefs of Staff.** The Joint Chiefs of Staff (JCS) consist of the Chairman, the Vice Chairman, the Chief of Staff of the Army, the Commandant of the Marine Corps, the Chief of Naval Operations, the Chief of Staff of the Air Force, the Chief of Space Operations, and the Chief of the National Guard Bureau. Headquartered at the Pentagon in Washington D.C., the Joint Staff is comprised of approximately 1,500 personnel from all six services and charged with assisting the Chairman in discharging their responsibility to the SecDef to provide unified strategic direction, operation, and integration of combatant land, naval, air, and space forces.



**The Chairman of the Joint Chiefs of Staff.** The Chairman of the Joint Chiefs of Staff (CJCS) is the principal military advisor to the President, the National Security Council, the Homeland Security Council, and the Secretary of Defense. Although the Chairman does not have command authority, in matters requiring global military strategic and operational integration, the Chairman, as global integrator, is responsible for providing advice to the SecDef on the arrangement of cohesive military actions in time, space, and purpose, executed as a whole to address trans-regional, all-domain, and multi-functional challenges.

**The Vice Chairman of the Joint Chiefs of Staff.** The DoD Reorganization Act of 1986 created the position of the Vice Chairman of the Joint Chiefs of Staff (VCJCS), who performs such duties as the CJCS may prescribe. By law, he is the second ranking member of the Armed Forces and replaces the CJCS in his absence or disability. Though the Vice Chairman was not originally included as a member of the JCS, Section 911 of the National Defense Authorization Act of 1992 made him a full voting member of the JCS.

**The Senior Enlisted Advisor to the CJCS.** The Senior Enlisted Advisor to the Chairman (SEAC) is a distinct military position and rank within the United States DoD and is designated the most senior enlisted service member, by position, in the United States Armed Forces. The SEAC serves as the principal advisor to the Chairman on all matters involving joint and combined total force integration, utilization, health of the force, and joint development for enlisted personnel. The SEAC represents the enlisted voice during engagements with leaders ranging from the Office of the Secretary of Defense to the civilian community to service leaders of foreign nations. Though not in the immediate chain of command, the SEAC serves as a vital conduit from the Chairman to the Service Senior Enlisted Advisors and the Command Senior Enlisted Leaders for the combatant commands to all enlisted members throughout the Joint Force.



*“Today’s operating environment is increasingly ambiguous, volatile, and complex. No longer is violent extremism the paramount threat. Rather, the 21st Century has witnessed the emergence of highly capable strategic competitors who are rapidly closing the gap in military capabilities and honing their capacity to disrupt rules-based order and reshape the international system. To deter adversarial aggression and win in a high-end fight, it is imperative that we build an innovative, adaptable, and lethal Joint Force. Our military services do not operate in a vacuum. Rather, they must synchronize unique capabilities to deliver the full complement of capabilities of the U.S. Armed Forces.*



*In 1947, Congress established an Air Force capable of preserving peace and security, providing defense, supporting national policies and objectives, and overcoming hostile enemies in conjunction with the other armed forces. Accordingly, our six services, in concert with international allies and partners, plan, train, and fight together as a team. Airmen are well equipped to support and execute all aspects of airpower, but it is only in tandem with our fellow Soldiers, Marines, Sailors, Guardians, and Coast Guardsmen that we advance and safeguard vital U.S. interests.*

*It is therefore imperative that today’s Airmen understand why and how service members in the Profession of Arms fight jointly. We must educate and equip ourselves with knowledge of joint concepts and of the other services’ unique capabilities. We must know the Air Force’s core missions and appreciate airpower’s contribution to the joint purpose and mission. We must recognize that each individual we stand and fight beside swore the same oath that we did, to support and defend the Constitution of the United States.”*

**Ramon “CZ” Colon Lopez  
Senior Enlisted Advisor to the CJCS**

**The Joint Staff.** The Joint Staff is comprised of unique departments and directorates tasked with the execution of distinct functions. These include the Joint Staff Information Management Division, Directorate of Management, J1 – Personnel and Manpower, J2 – Intelligence, J3 – Operations, J4 – Logistics, J5 – Strategic Plans and Policy, J6 – Command, Control, Communications, and Computers/Cyber, J7 – Joint Force Development, and J8 – Joint Force Structure, Resources, and Assessment. These departments ensure planning, policies, intelligence, manpower, communications, and logistics function are translated into action. The Office of the Chairman also contains supporting elements that provide assistance to the CJCS, VCJCS, and the JCS on matters of advisement.

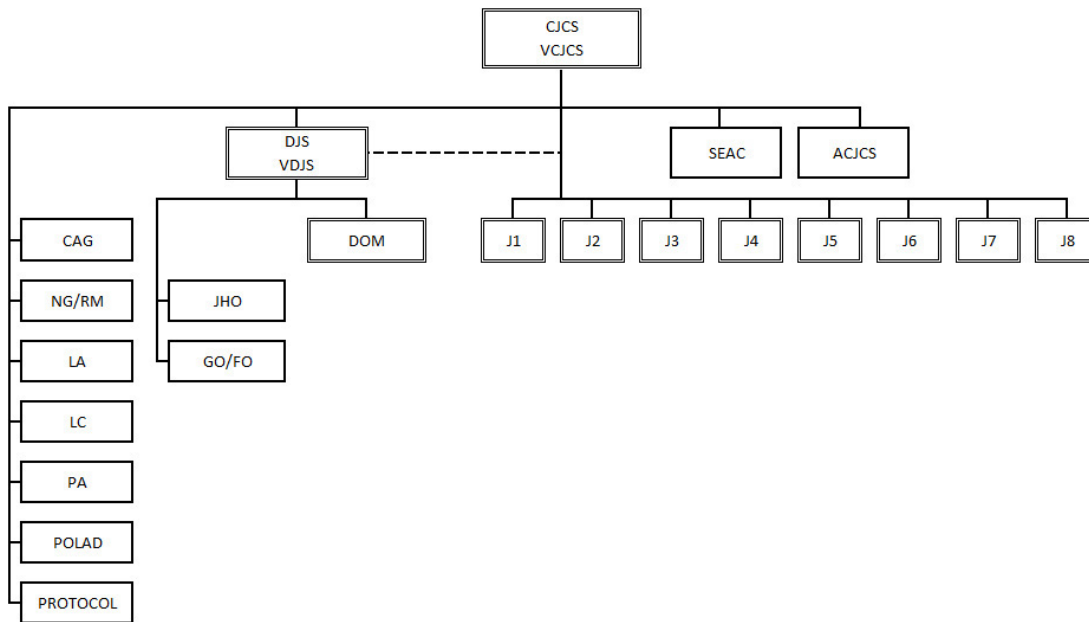

**For more information:** [The Joint Staff](#)

- <https://www.jcs.mil/About/>

## COMBATANT COMMANDS

The National Security Act of 1947 and Title 10, U.S. Code provide the basis for establishment of unified command of U.S. military forces. The Unified Command Plan (UCP) establishes the missions and responsibilities for CCMD Commanders (CCDR). The President, through the Secretary of Defense and with the advice and assistance of the Chairman of the Joint Chiefs of Staff, establishes combatant commands for the performance of military missions and prescribes the force structure of such commands.

CCDRs exercise command authority (COCOM) of assigned forces. The CCDR may delegate operational control (OPCON), tactical control (TACON), or establish support command relationships of assigned forces. Airmen assigned to CCMDs perform their missions under the command authority of the CCDR to which they are assigned and support the mission and strategic objectives of that CCMD. Relative to their commands, CCDRs develop geographic or functional strategies which determine force employment. These strategies articulate the pursuit of global, regional, or functional objectives within the context of national strategy to achieve national policy objectives specific to designated region or function.

Assignment of forces is managed through Global Force Management (GFM). GFM is a series of processes that weigh the services' capacity to generate forces against CCDR requirements while building readiness and a credible deterrent force. Through the GFM process, Services provide sufficient, ready, and available forces to execute national strategy. GFM enables proper distribution of forces among the CCMDs through the assignment of forces, provides a mechanism to temporarily adjust force distribution to meet dynamic global challenges through the allocation process, and ensures the availability of apportioned forces, described as the services' estimate of the number of forces that can reasonably be made available over a general timeline should a surge of forces be required.

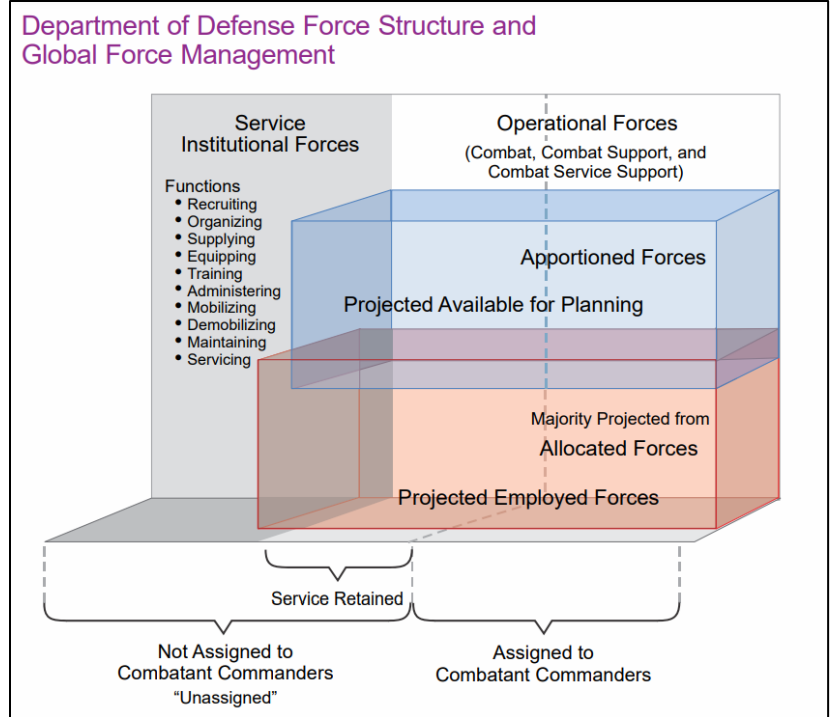

In total, there are eleven CCMDs, seven of which are geographic and four of which are functional. The geographic commands include U.S. Africa Command, U.S. Central Command, U.S. European Command, U.S. Indo-Pacific Command, U.S. Northern Command, U.S. Southern Command, and U.S. Space Command. The functional commands include U.S. Cyber Command, U.S. Special Operations Command, U.S. Strategic Command, and U.S. Transportation Command.

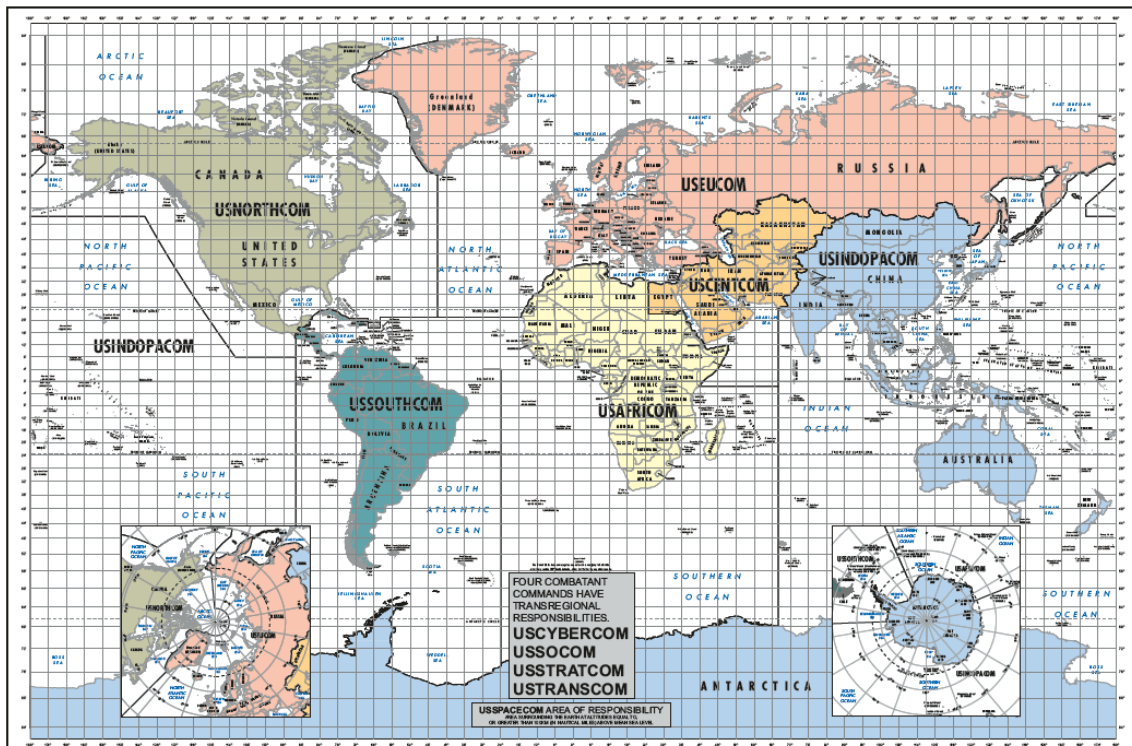



## The Joint Team

**U.S. Africa Command.** USAFRICOM, with partners, counters trans-national threats and malign actors, strengthens security forces, and responds to humanitarian crises in order to advance U.S. national interests and promote regional security, stability, and prosperity.



**U.S. Central Command.** USCENTCOM directs and enables military operations and activities with allies and partners to increase regional security and stability in support of enduring U.S. interests.



**U.S. Cyber Command.** USCYBERCOM directs, synchronizes, and coordinates cyberspace planning and operations – to defend and advance national interests – in collaboration with domestic and international partners.



**U.S. European Command.** USEUCOM executes a full range of multi-domain operations in coordination with Allies and partners to support NATO, deter Russia, enable global operations, and counter trans-national threats in order to defend the Homeland forward and fortify Euro-Atlantic security. Should deterrence fail, USEUCOM is prepared to fight alongside allies and partners to prevail in any conflict.



**U.S. Indo-Pacific Command.** USINDOPACOM implements a combat credible deterrence strategy capable of denying our adversaries' sustained air and sea dominance by focusing on posturing the Joint Force to win before fighting while being ready to fight and win, if required.



**U.S. Northern Command.** USNORTHCOM defends our homeland – deters, detects, denies, and defeats threats to the United States, conducts security cooperation activities with allies and partners, and supports civil authorities.



## The Joint Team

**U.S. Southern Command.** USSOUTHCOM deters aggression, defeats threats, rapidly responds to crises, and builds regional capacity, working with our allies, partner nations, and U.S. Government team members to enhance security and defend the U.S. homeland and our national interests.



**U.S. Space Command.** USSPACECOM conducts operations in, from, and to space to deter conflict and, if necessary, defeat aggression, deliver space combat power for the Joint/Combined Force, and defend U.S. vital interests with allies and partners.



**U.S. Special Operations Command.** USSOCOM develops and employs fully capable Special Operations Forces to conduct global special operations and activities as part of the Joint Force to support persistent, networked, and distributed combatant command operations and campaigns against state and non-state actors to protect and advance U.S. policies and objectives.



**U.S. Strategic Command.** USSTRATCOM employs nuclear, cyber, global strike, joint electronic warfare, missile defense, and intelligence capabilities to deter aggression, decisively and accurately respond if deterrence fails, assure allies, shape adversary behavior, defeat terror, and define the force of the future.



**U.S. Transportation Command.** USTRANSCOM conducts globally integrated mobility operations, leads the broader Joint Deployment and Distribution Enterprise, and provides enabling capabilities to project and sustain the Joint Force in support of national objectives.



**For more information:** [Title 10, U.S. Code, JP 5-0, Joint Planning](#)

- <https://uscode.house.gov/view.xhtml?path=/prelim@title10&edition=prelim>
- [https://www.jcs.mil/Portals/36/Documents/Doctrine/pubs/jp5\\_0.pdf?ver=us\\_fQ\\_pGS\\_u65ateysmAng%3d%3d](https://www.jcs.mil/Portals/36/Documents/Doctrine/pubs/jp5_0.pdf?ver=us_fQ_pGS_u65ateysmAng%3d%3d)

## JOINT COMPONENT COMMANDS AND JOINT TASK FORCES

The JFC normally assigns broad missions to the component commanders. Each mission is assigned a specification of a supported commander for that mission. The designation of Joint Force air, land, maritime and special operations component commanders (Joint Force Air Component Commander [JFACC], Joint Force Land Component Commander [JFLCC], Joint Force Maritime Component Commander [JFMCC], and Joint Force Special Operations Component Commander [JFSOCC])

respectively) is at the discretion of the JFC. As an example, the JFC may designate the JFACC as the supported commander for counter air, strategic attack, air interdiction, and theater airborne intelligence, surveillance, and reconnaissance. As such, the JFACC is responsible to the JFC for planning, coordinating, executing, and assessing primary mission activities, while other component commanders support the JFACC. Because most services have forces that operate in the air domain, the designation of functional commanders allows greater synergy by integrating similar activities across service boundaries.

U.S. Forces are required by national command authorities to respond on short notice to spontaneous, unpredictable crises. When a crisis requires a military response, the Secretary of Defense, combatant commander, subordinate unified commander, or an existing JFC can form a Joint Task Force (JTF) tailored to address the crisis. The JTF is the primary construct for joint operations, and its organizational structure capitalizes on the unique capabilities of each service, providing flexibility to tailor the size and makeup of the force to accomplish specific tasks during peace, crisis, or war.

Some JTFs, known as Combined Joint Task Forces (CJTF) include partner nations. A CJTF is a deployable multinational, multiservice task force generated and tailored primarily but not exclusively for military operations not involving the defense of the alliance territory, such as humanitarian relief and peacekeeping. CJTFs provide a flexible and efficient means to enable partner nations to generate forces on short notice, providing rapidly deployable task forces with appropriate command and control.

Joint Task Forces do not normally have standing Air Force structures and require the Air Force establish an Air Expeditionary Task Force (AETF) as a temporary Air Force Service component command. The commander of the AETF would either be the commander, Air Force Forces (COMAFFOR) directly responsible to the JTF commander, or established in a supporting role to the JTF under the authority of the theater air component commander.

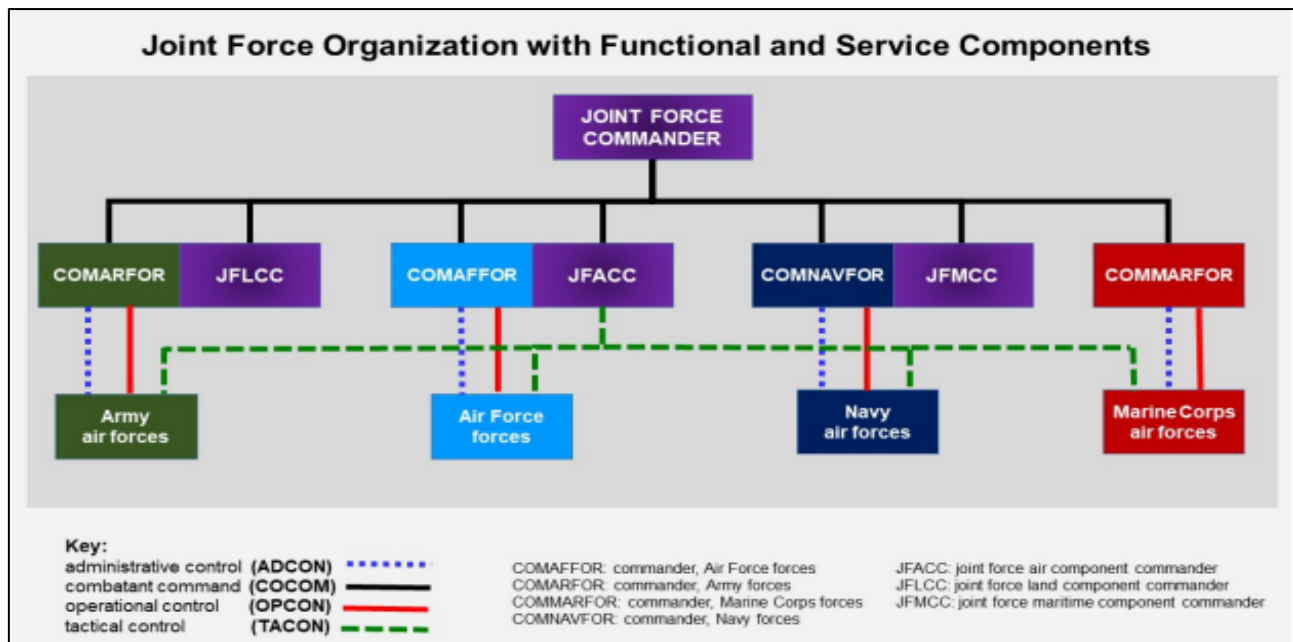

JTFs have a specific, limited objective, and once they have executed their missions, they are dissolved. Historically, JTFs have been constructed to execute disaster and humanitarian relief missions, combat operations, and counterdrug operations. Some examples of present-day JTFs and CJTFs include:

**Combined Joint Task Force – Horn of Africa.** CJTF-HOA is the USAFRICOM organization that conducts operations in the region to enhance partner nation capacity, promote regional security and stability, dissuade conflict, and protect U.S. and coalition interests. CJTF-HOA is comprised of multiple U.S. military service branches as well as allied and partner armed services personnel, working together against malign actors to strengthen collective security forces and respond to crises to promote regional security, stability, and prosperity.



**Combined Joint Task Force – Operation Inherent Resolve.** Established in 2014 at the request of Iraqi and Syrian governments to degrade and destroy the Islamic State of Iraq and the Levant (ISIL), CJTF-OIR is comprised of forces from over 77 nations and five international organizations. This combined JTF advises, assists, and enables partner forces until they can independently defeat Daesh in designated areas of Iraq and Syria in order to set conditions for long-term security cooperation frameworks.



**Joint Task Force – Bravo.** Stood up at the request of the Honduran government to increase the number and size of combined training exercises in the Republic of Honduras, JTF-Bravo was established in 1984, making it the longest standing JTF in the U.S. military. JTF-Bravo conducts and supports USSOUTHCOM operations, activities, and investments across all domains in support of U.S. Government agencies and partner nations in Central America, in order to enhance regional security and defend the U.S. homeland and national interests.



**Joint Task Force – Civil Support.** JTF-CS provides command and control for DoD forces deployed in support of the National Response Plan, specifically, managing the consequences of a domestic chemical, biological, radiological, nuclear, or high-yield explosive (CBRNE) incident. JTF-CS supports USNORTHCOM and is able to respond anywhere within North America within twenty-four hours to lead technical and non-technical search and rescue, security, hazard analysis, evidence collection, mission command, logistics support, aviation support, and medical support after an actual or threatened CBRNE incident.



**Joint Task Force – National Capital Region.** JTF-NCR was established in the aftermath of the September 11, 2001 attacks to address threats to the National Capital Region and provide DoD support to civil authorities. A joint command subordinate to USNORTHCOM, JTF-NCR conducts homeland defense and defense support of civil authorities. It is a collaborative, regional team focused on safeguarding the National Capital Region.



**For more information:** [\*JP 3-30, Joint Air Operations\*](#), [\*The Combined Joint Task Forces Concept\*](#)

- [https://www.jcs.mil/Portals/36/Documents/Doctrine/pubs/jp3\\_30.pdf](https://www.jcs.mil/Portals/36/Documents/Doctrine/pubs/jp3_30.pdf)
- <https://www.nato.int/docu/comm/1999/9904-wsh/pres-eng/16cjtf.pdf>

## DEFENSE AGENCIES AND DOD FIELD ACTIVITIES

The Department of Defense cannot operate without support from defense agencies and field activities outside the military services that perform functions critical to the joint mission. Pursuant to U.S. Code Title 10, Section 191, the Secretary of Defense, when they determine that it is more effective, economical, or efficient, may provide for the performance or supply of a service activity that is common to more than one military department by a single DoD agency. Such agencies are designated Defense Agencies or

DoD Field Activities and are commonly referred to as the 4th Estate.

There are more than two dozen defense agencies and field activities outside of the military branches which have been established for specific purposes in support of the DoD mission to provide the military forces needed to deter war and ensure the Nation's security. These organizations' missions range from combat support to research and development to security cooperation. Some examples of these agencies include:

**Defense Contract Management Agency.** The Defense Contract Management Agency (DCMA) is the independent eyes and ears of DoD and its partners, enhancing warfighter lethality by ensuring timely delivery of quality products, and providing relevant acquisition insight supporting affordability and readiness. The Defense Contract Management Agency is, first and foremost, a product delivery organization. Our Nation's warfighters expect our defense industry to produce and deliver the equipment they need to fight, survive, and win. DCMA's integrated team of acquisition and support professionals makes this happen.



**Defense Health Agency.** The Defense Health Agency (DHA) is a joint, integrated Combat Support Agency that enables the Army, Navy, and Air Force medical services to provide a medically ready force and ready medical force to combatant commands in both peacetime and wartime. The DHA uses the principles of Ready Reliable Care to advance high reliability practices across the Military Health System by improving our system operations, driving innovative solutions, and cultivating a culture of safety.



**Defense Information Systems Agency.** The Defense Information Systems Agency (DISA) conducts Department of Defense Information Networks (DODIN) operations for the joint warfighter to enable lethality across all warfighting domains in defense of our Nation. DISA plans, engineers, acquires, tests, fields, operates, and assures information-sharing capabilities, command and control solutions, and a global enterprise infrastructure to support DoD and national-level leadership.



**Defense Intelligence Agency.** The Defense Intelligence Agency (DIA) provides intelligence on foreign militaries to prevent and decisively win wars. Additionally, DIA provides military intelligence to warfighters, defense policymakers, and force planners in the DoD and Intelligence Community, in support of U.S. military planning, operations, and weapons systems acquisition. DIA plans, manages, and executes intelligence operations during peacetime, crisis, and war.



**Defense Logistics Agency.** The Defense Logistics Agency (DLA) delivers readiness and lethality to the "Warfighter Always" and supports our Nation through quality, proactive global logistics. DLA is the Nation's combat logistics support agency that manages the end-to-end global defense supply chain – from raw materials to end user disposition – for the military services, combatant commands, other federal, state, and local agencies, and partner and allied nations.



**Defense Security Cooperation Agency.** The Defense Security Cooperation Agency (DSCA) advances U.S. defense and foreign policy interests by building the capacity of foreign partners in order to encourage and enable allies and partners to respond to shared challenges. DSCA’s vision is to lead the Security Cooperation enterprise in delivering effective, enduring, and timely solutions, and serve as the source for security cooperation expertise and innovation for our defense and foreign policy stakeholders to ensure the United States remains the global partner of choice.



**Defense Threat Reduction Agency.** The Defense Threat Reduction Agency (DTRA) enables the DoD, the U.S. Government, and international partners to counter and deter Weapons of Mass Destruction (WMD) and emerging threats. It enables the services and USSTRATCOM to ensure strategic deterrence is safe and credible and directly supports strategic response through nuclear readiness and modernization.



**National Security Agency.** The National Security Agency (NSA) provides intelligence support to military operations through signals intelligence activities, while cybersecurity personnel, products, and services ensure that military communications and data remain secure and out of the hands of our adversaries. NSA’s cybersecurity mission also produces and packages the codes that secure our Nation’s weapons systems. Additionally, it sets common protocols and standards so that our military can securely share information with our allies, NATO, and coalition forces around the world.



**National Geospatial-Intelligence Agency.** The National Geospatial-Intelligence Agency (NGA) provides geospatial intelligence for our Nation’s security. NGA has a responsibility to provide the products and services that decision makers, military service members, and first responders need, when they need it most. As a member of the Intelligence Community and the Department of Defense, NGA supports a unique mission set. NGA is committed to acquiring, developing, and maintaining the proper technology, people, and processes that will enable overall mission success.



## ALLIANCES AND PARTNERSHIPS

The Joint Force is significantly strengthened via a robust network of multinational alliances and partnerships. In terms of national security, alliances are formal agreements between two or more nations, formalized by means of a treaty, binding the signatories to support the other(s), particularly in time of war. Partnerships, often referred to as “strategic partnerships” are less formal than alliances and are not endorsed via treaty. Rather, partnerships are understandings between two or more nations that enable parties on both sides to learn from each other to enhance cooperation and build mutually beneficial relationships.

“Our world is at an inflection point. Global dynamics have shifted. New crises demand our attention. And in this moment of accelerating global challenges...one thing is certain: we will only succeed in advancing American interests and upholding our universal values by working in common cause with our closest allies and partners.”

**President Joseph R. Biden, Jr.**  
46th President of the United States



The United States has an unmatched network of alliances and partnerships that enables our Nation to disrupt threats before they can reach our shores and ensures peace, security, and prosperity for the American people. Some of these include:

**Five Eyes.** Five Eyes (FVEY) is a cooperative intelligence alliance comprised of the United States, United Kingdom, Canada, Australia, and New Zealand. Founded by the United Kingdom-United States of America Agreement (UKUSA) in 1946, FVEY is the world's oldest intelligence-sharing relationship, enabling partner nations to share collected multi-source intelligence to safeguard and advance common objectives and interests.

**North American Aerospace Defense Command.** The North American Aerospace Defense Command (NORAD) is a combined organization of the United States and Canada responsible for providing aerospace warning, air sovereignty, and protection for North America and the nations' critical infrastructure from any aerospace or maritime threat. NORAD maintains that a capable and persistent defense at home is a prerequisite to projecting power to a globally integrated forward fight. Accordingly, it engages in improving critical infrastructure resiliency, strengthening partnerships, and providing rapid, flexible options and decision space for national leaders to respond to threats against the homeland.

**North Atlantic Treaty Organization.** Founded in 1949 with the signing of the Washington Treaty, the North Atlantic Treaty Organization (NATO) is a security alliance comprised of 30 member nations in North America and Europe. The foundational goal of this organization is to safeguard the allies' freedom and security by political and military means. At the core of the alliance is the concept that an attack against one ally is an attack against all. NATO ensures collaboration of member states to prevent and respond to global threats such as cyber-attacks, terrorism, piracy, and various forms of aggression that jeopardize the alliance and its global network of partners.

**Quadrilateral Security Dialogue.** Initiated in 2007 by Japanese Prime Minister Shinzo Abe, the Quadrilateral Security Dialogue, often referred to as the Quad, is a diplomatic and military arrangement between Australia, India, Japan, and the United States. Members of the Quad assert a shared vision for a "Free and Open Indo-Pacific" and a "rules-based maritime order in the East and South China seas," necessary to counter Chinese maritime claims.

**Pacific Partnership.** Established in 2006, the Pacific Partnership is an annual deployment of the U.S. Navy's Pacific Fleet, in coordination with regional governments, militaries, humanitarian, and other non-governmental organizations, to visit countries in the Indo-Pacific region to enhance relationships, interoperability, and security ties among the nations. The Pacific Partnership provides humanitarian, medical, dental, and civil engineering assistance to the nations of the Pacific.

**State Partnership Program.** The State Partnership Program (SPP), established in 1993, is a joint program of the United States DoD and individual states, territories, and the District of Columbia. The program is managed by the National Guard Bureau (NGB). The SPP matches NGB units of the various states, territories, and the District of Columbia with foreign nations around the world in support of security cooperation objectives, crisis relief, and humanitarian activities. The SPP has been successfully building relationships for over 25 years and now includes 85 partnerships with 93 nations around the globe.

## Chapter 4 - WHAT IS JOINT WARFIGHTING

### JOINT OPERATIONS OVERVIEW

A multitude of DIME-FIL factors affect national security in today’s complex operating environment, requiring a whole of government approach and an atmosphere of inclusiveness to advance and safeguard vital U.S. national interests – protecting the American people, expanding America’s prosperity, and realizing and defending our democratic values.

The success of joint operations requires unity of effort and unified action between military forces, governmental and nongovernmental entities, international partners, and the private sector. This necessitates that all stakeholders, regardless of service, organization, or other affiliation, coordinate activities and synchronize efforts toward common objectives.

Joint operations address regional and trans-regional threats across a dynamic geo-political landscape in which problems and mission partner interests, roles, and approaches evolve continually. In the past, militaries engaged in conflict primarily in the land, maritime, and air domains. Future conflict will likely be trans-regional, multi-domain, and multifunctional, spanning the full spectrum of the conflict and competition continuums. To defeat our adversaries and abate the advancement of our pacing threats, a coordinated and unified effort across the joint team is imperative.

**Global Integration.** As the global integrator, the Chairman of the Joint Chiefs of Staff considers and balances the demands and requirements of the geographic and functional commands in a complex and resource-constrained operational landscape to prepare best military advice for civil leader decisions and actions. Global integration requires a balanced, universally-oriented, and regionally-aware perspective to expand the Joint Force’s competitive space both geographically and functionally across all domains. Thus, the Chairman, in collaboration with the Joint Staff and the services, “sets the globe” in force management, force readiness, and force movement by providing a global perspective on risk, assumptions, priorities, and options to inform Presidential and SecDef decision-making, setting the conditions for CCMDs at the speed of relevancy.

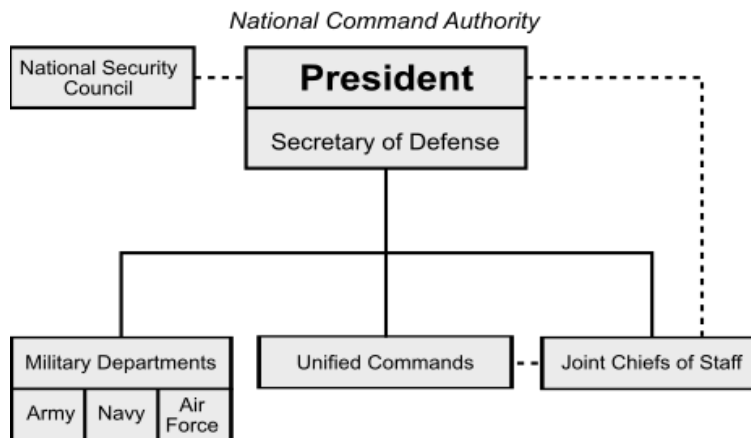

**Mission Command and Operational Art.** The primary way the Department of Defense employs two or more services, from at least two military departments, in a single operation is through joint operations. Joint operations are military actions conducted by joint forces and those service forces employed in specified command relationships with each other. A Joint Force is one composed of significant elements,



assigned or attached, of two or more military departments operating under a single Joint Force Commander (JFC) who exercises mission command.

Based on guidance from the President and SecDef, Geographic Combatant Commanders (GCCs) and Functional Combatant Commanders (FCCs) translate national security policy, strategy, and available military forces into theater and functional strategies to achieve national and regional strategic objectives. CCMD strategies are broad statements consisting of the CDR's vision, guided by and prepared in the context of SecDef priorities outlined in the Guidance for Employment of the Force and the CJCS's objectives articulated in the National Military Strategy.

Service members at all echelons must understand mission command, defined as the conduct of military operations through decentralized execution based on mission-type orders. The three attributes of mission command – trust, understanding, and intent – ensure the disciplined initiative of subordinates to operate at the speed of the problem while providing senior leaders the decision space to better set conditions.

- ★ **Trust.** Trust is the reliance on the integrity, strength, and ability of a person or thing. In the Joint Force, trust fortifies relationships both up and down the chain of command and across services and organizations. Service members are assured that they can rely on each other based on their shared values of the Profession of Arms and joint core values.
- ★ **Understanding.** Understanding is built on continual dialogue, feedback, and investment in relationships. It entails exposure to and consideration of diverse perspectives, interests, authorities, capabilities, and policies of partners.
- ★ **Intent.** Commander's intent describes the desired end state and provides unified focus for subordinates at all levels. Service members that understand commander's intent are empowered to employ disciplined initiative in a complex, fast-paced, and unpredictable operational environment.

Mission command enables speed, agility, and decisiveness of the Joint Force. When effectively highlighted and employed, the three attributes of mission command assure empowerment of stakeholders as well as harmony and effectiveness of joint operations.

## PRINCIPLES OF JOINT OPERATIONS

The Principles of Joint Operations are formed around the nine traditional Principles of War – Objective, Offensive, Mass, Maneuver, Economy of Force, Unity of Command, Security, Surprise, and Simplicity. Three additional principles – Restraint, Perseverance, and Legitimacy – are relevant to how the Armed Forces of the United States use combat power across the range of military operations. These principles are rules and guidelines that represent fundamental truths in the practice of war and military operations.

**Objective.** The purpose of specifying the objective is to direct every military operation toward a clearly defined, decisive, and achievable goal. The purpose of military operations is to achieve the military objectives that support attainment of the overall political goals of the conflict. This frequently involves the destruction of the enemy armed forces' capabilities and their will to fight. The objective of joint operations not involving this destruction might be more difficult to define; nonetheless, it too must be clear from the beginning. Objectives must directly, quickly, and economically contribute to the purpose of the operation. Each operation must contribute to strategic objectives. Additionally, changes to the military objectives may occur because political and military leaders gain a better understanding of the situation, or they may occur because the situation itself changes. The changes may be very subtle, but if not made, achievement of the military objectives may no longer support the political goals, legitimacy may be undermined, and force security may be compromised.

**Offensive.** The purpose of an offensive action is to seize, retain, and exploit the initiative. Offensive action is the most effective and decisive way to achieve a clearly defined objective. Offensive operations are the means by which a military force seizes and holds the initiative while maintaining freedom of action and achieving decisive results. The importance of offensive action is fundamentally true across all levels of war. Commanders adopt the defensive only as a temporary expedient and must seek every opportunity to seize or regain the initiative. An offensive spirit must be inherent in the conduct of all defensive operations.

**Mass.** The purpose of mass is to concentrate the effects of combat power at the most advantageous place and time to produce decisive results. To achieve mass, appropriate Joint Force capabilities are integrated and synchronized where they will have a decisive effect in a short period of time. Mass often must be sustained to have the desired effect. Massing effects of combat power, rather than concentrating forces, can enable even numerically inferior forces to produce decisive results and minimize human losses and waste of resources.

**Maneuver.** The purpose of maneuver is to place the enemy in a position of disadvantage through the flexible application of combat power. Maneuver is the movement of forces in relation to the enemy to secure or retain positional advantage, usually to deliver—or threaten delivery of—the direct and indirect fires of the maneuvering force. Effective maneuver keeps the enemy off balance, thus also protecting the friendly force. It contributes materially to exploiting successes, preserving freedom of action, and reducing vulnerability by continually posing new problems for the enemy.

**Economy of Force.** The purpose of economy of force is to expend minimum essential combat power on secondary efforts in order to allocate the maximum possible combat power on primary efforts. Economy of force is the judicious employment and distribution of forces. It is the measured allocation of available combat power to such tasks as limited attacks, defense, delays, deception, or even retrograde operations to achieve mass elsewhere at the decisive point and time.

**Unity of Command.** The purpose of unity of command is to ensure unity of effort under one responsible commander for every objective. Unity of command means that all forces operate under a single commander with the requisite authority to direct all forces employed in pursuit of a common purpose. During multinational operations and interagency coordination, unity of command may not be possible, but the requirement for unity of effort becomes paramount. Unity of effort—the coordination and cooperation toward common objectives, even if the participants are not necessarily part of the same command or organization—is the product of successful unified action.

**Security.** The purpose of security is to prevent the enemy from acquiring unexpected advantage. Security enhances freedom of action by reducing friendly vulnerability to hostile acts, influence, or surprise. Security results from the measures taken by commanders to protect their forces. Staff planning and an understanding of enemy strategy, tactics, and doctrine enhance security. Risk is inherent in military operations. Application of this principle includes prudent risk management, not undue caution.

**Surprise.** The purpose of surprise is to strike at a time or place or in a manner for which the enemy is unprepared. Surprise can help the commander shift the balance of combat power, thus achieving success well out of proportion to the effort expended. Factors contributing to surprise include speed in decision-making, information sharing and force movement, effective intelligence, deception, application of unexpected combat power, operations security, and variations in tactics and methods of operation.

**Simplicity.** The purpose of simplicity is to increase the probability that plans and operations will be executed as intended by preparing clear, uncomplicated plans and concise orders. Simplicity contributes to successful operations. Simple plans and clear, concise orders minimize misunderstanding and

confusion. When other factors are equal, the simplest plan is preferable. Simplicity in plans allows better understanding and execution planning at all echelons. Simplicity and clarity of expression greatly facilitate mission execution in the stress, fatigue, fog of war, and complexities of modern combat, and are especially critical to success in multinational operations.

**Restraint.** The purpose of restraint is to limit collateral damage and prevent the unnecessary use of force. A single act could cause significant military and political consequences; therefore, judicious use of force is necessary. Restraint requires the careful and disciplined balancing of the need for security, the conduct of military operations, and the national strategic end state. Failure to understand and comply with established Rules of Engagement (ROEs) can result in fratricide, mission failure, or national embarrassment. Restraint is best achieved when ROEs issued at the beginning of an operation address the most anticipated situations that may arise.

**Perseverance.** The purpose of perseverance is to ensure the commitment necessary to attain the national strategic end state. Perseverance involves preparation for measured, protracted military operations in pursuit of the national strategic end state. Some joint operations may require years to reach the termination criteria. The underlying causes of the crisis may be elusive, making it difficult to achieve decisive resolution. The patient, resolute, and persistent pursuit of national goals and objectives often is essential to success. This will frequently involve diplomatic, economic, and informational measures to supplement military efforts.

**Legitimacy.** The purpose of legitimacy is to maintain legal and moral authority in the conduct of operations. Legitimacy, which can be a decisive factor in operations, is based on the actual and perceived legality, morality, and rightness of the actions from the various perspectives of interested audiences. These audiences include national leadership, domestic populations, governments in the operational area, and nations and organizations around the world. Committed forces must sustain the legitimacy of the operation and the host government, where applicable. Security actions must be balanced with legitimacy concerns. All actions must be considered in the light of potentially competing strategic and tactical requirements, and must exhibit fairness in dealing with competing factions where appropriate.

**For more information:** [\*JP 3-0, Joint Campaigns and Operations\*](#)

- [https://jdeis.js.mil/jdeis/new\\_pubs/jp3\\_0.pdf](https://jdeis.js.mil/jdeis/new_pubs/jp3_0.pdf)

## JOINT FUNCTIONS

A joint function is a grouping of capabilities and activities that enable Joint Force Commanders to synchronize, integrate, and direct joint operations. There are seven joint functions common to joint operations: command and control (C2), information, intelligence, fires, movements and maneuver, protection, and sustainment. Commanders leverage the capabilities of multiple joint functions during operations. The joint functions apply to all joint operations across the competition continuum and enable both traditional and information warfare, but to different degrees, conditions, and standards, while employing different tactics, techniques, and procedures. The integration of activities across joint functions to accomplish tasks and missions occurs at all levels of command. Joint functions reinforce and complement one another, and integration across them is essential to mission accomplishment.

- ✦ **Command and Control.** C2 encompasses the exercise of authority and direction by a commander over assigned and attached forces to accomplish the mission. The JFC provides operational vision, guidance, and direction to the joint force.
- ✦ **Information.** The information function encompasses the management and application of information to support achievement of objectives. It is the deliberate integration with other joint functions to change or maintain perceptions, attitudes, and other elements that drive desired

relevant actor behaviors and to support human and automated decision making.

- ★ **Intelligence.** The intelligence function informs JFCs about adversary intentions, capabilities, centers of gravity, critical factors, vulnerabilities, and future courses of action and helps commanders and staffs understand friendly, neutral, and threat networks.
- ★ **Fires.** Fires is the use of weapon systems or other actions to create specific lethal or non-lethal effects on a target or objects of influence in accordance with U.S. and international law. Joint fires are delivered during the employment of forces from two or more components in coordinated action to produce desired results in support of a common objective.
- ★ **Movement and Maneuver.** The movement and maneuver function encompasses the disposition of joint forces to conduct operations by securing positional or informational advantages across the competition continuum and exploiting tactical success to achieve operational and strategic objectives.
- ★ **Protection.** Protection is all efforts to secure and defend the effectiveness and survivability of mission-related military and non-military personnel, equipment, facilities, information, and infrastructure deployed or located within or outside the boundaries of a given operational area to maintain mission effectiveness.
- ★ **Sustainment.** Sustainment is the provision of logistics and personnel services support to maintain operations through mission accomplishment and redeployment of the force. Sustainment gives the JFC the means for freedom of action, endurance, and extending operational reach.

**For more information:** [\*JP 3-0, Joint Campaigns and Operations\*](#)

- [https://jdeis.js.mil/jdeis/new\\_pubs/jp3\\_0.pdf](https://jdeis.js.mil/jdeis/new_pubs/jp3_0.pdf)

## THE JOINT SERVICE MEMBER

The success of joint operations hinges on the competence and professionalism of the individual members of the Joint Force. Accordingly, the greatest and most valuable competitive advantage the Joint Force maintains in a high-end fight is the individual service member that has dedicated their purpose and industry to the Profession of Arms. The service members that comprise the most distinguished and capable military force in the world adhere to the following Joint Core Values:

- ★ **Duty.** Duty is our foremost value. It binds us together and conveys our moral commitment or obligation as defenders of the Constitution and servants of the Nation. As members of the Profession of Arms, we fulfill our duty without consideration of self-interest, sacrificing our lives if needed. From duty comes responsibility.
- ★ **Honor.** Honor is the code of behavior that defines the ethical fulfillment of our duties. It is that quality that guides us to exemplify ethical and moral behavior; never to lie, cheat or steal; to abide by an uncompromising code of integrity, to respect human dignity; to have respect and concern for each other. It is the quality of maturity, dedication, trust, and dependability that commits members of the Profession of Arms to act responsibly, to be accountable for actions, to fulfill obligations, and to hold others accountable for their actions.
- ★ **Courage.** The United States of America is blessed with service members whose courage knows no boundaries. Even in warfare characterized by advanced technology, individual fighting spirit and courage remain essential. Courage has both physical and moral aspects, encompassing both bravery and fortitude.
  - Physical Courage has, throughout history, defined warriors. It is the ability to confront

physical pain, hardship, death, or threat of death. Physical courage in a leader is most often expressed in a willingness to act, even alone if necessary, in situations of danger and uncertainty.

- Moral courage is the ability to act rightly in the face of popular opposition, or discouragement. This includes the willingness to stand up for what one believes to be right even if that stand is unpopular or contrary to conventional wisdom. This involves risk taking, tenacity, and accountability.
- ★ **Integrity.** Integrity is the quality of being honest and having strong moral principles. Integrity is the bedrock of our character and the cornerstone for building trust. Trust is an essential trait among service members—trust by seniors in the abilities of their subordinates and by juniors in the competence and support of their seniors. American service members must be able to rely on each other, regardless of the challenge at hand; they must individually and collectively say what they mean and do what they say.
- ★ **Selfless Service.** Selfless service epitomizes the quality of putting our Nation, our military mission(s), and others before ourselves. Members of the Profession of Arms do not serve to pursue fame, position, or money. They give of themselves for the greater good. Selfless service is the enabler of teamwork, the cooperative effort by the members of a group to achieve common goals.

Members of the Armed Forces of the United States must internalize and embody these values of the Profession of Arms. Their adherence to duty, honor, courage, integrity, and selfless service helps promulgate a joint warfighting mindset, producing a synergy that multiplies the effects of individual actions. They are the cornerstones of the freedom that we secure across the globe.

**For more information:** [Guidance on Fostering Professionalism within the Department of Defense](#)

- [https://comptroller.defense.gov/Portals/45/documents/micp\\_docs/Topical/OSD001895-15\\_FOD\\_Final.pdf](https://comptroller.defense.gov/Portals/45/documents/micp_docs/Topical/OSD001895-15_FOD_Final.pdf)

## CODE OF CONDUCT FOR MEMBERS OF THE U.S. ARMED FORCES

- I.** I am an American, fighting in the forces which guard my country and our way of life. I am prepared to give my life in their defense.
- II.** I will never surrender of my own free will. If in command, I will never surrender the members of my command while they still have the means to resist.
- III.** If I am captured I will continue to resist by all means available. I will make every effort to escape and aid others to escape. I will accept neither parole nor special favors from the enemy.
- IV.** If I become a prisoner of war, I will keep faith with my fellow prisoners. I will give no information or take part in any action which might be harmful to my comrades. If I am senior, I will take command. If not, I will obey the lawful orders of those appointed over me and will back them up in every way.
- V.** When questioned, should I become a prisoner of war, I am required to give name, rank, service number and date of birth. I will evade answering further questions to the utmost of my ability. I will make no oral or written statements disloyal to my country and its allies or harmful to their cause.
- VI.** I will never forget that I am an American, fighting for freedom, responsible for my actions, and dedicated to the principles which made my country free. I will trust in my God and in the United States of America.

**For more information:** [\*Executive Orders | National Archives\*](#)

- <https://www.archives.gov/federal-register/codification/executive-order/10631.html>

## Chapter 5 - HOW THE AIR FORCE FITS INTO THE JOINT FIGHT

### AIR FORCE FUNCTIONS

The Department of the Air Force (DAF) is composed of air, space, and cyber forces and is responsible to organize, train, and equip forces to project power for the conduct of prompt and sustained combat operations, military engagement, and security cooperation in defense of the Nation. In a variety of capacities, Total Force Airmen support the other military services and the Joint Force. The Air Force provides the Nation with global vigilance, global reach, and global power in the form of in-place, forward based, and expeditionary forces. These forces possess the capacity to deter aggression and violence by state, non-state, and individual actors to prevent conflict. Should deterrence fail, the Air Force stands ready to prosecute the full range of military operations in support of U.S. national interests.

In addition to service functions common to each military branch, the Air Force develops concepts, doctrine, tactics, techniques, and procedures to deliver forces to perform the following specific functions:

- ✦ Conduct nuclear operations in support of strategic deterrence, to include providing and maintaining nuclear surety and capabilities.
- ✦ Conduct offensive and defensive operations, to include appropriate air and missile defense, to gain and maintain air superiority and air supremacy as required, to enable the conduct of operations by U.S. and allied land, sea, air, space, and special operations forces.
- ✦ Conduct global precision attack, to include strategic attack, interdiction, close air support, and prompt global strike.
- ✦ Provide timely, globally integrated intelligence, surveillance, and reconnaissance capability and capacity from forward deployed locations and globally distributed centers to support world-wide operations.
- ✦ Provide rapid global mobility to employ and sustain organic air and space forces and other military service and U. S. Special Operations Command forces, as directed, to include airlift forces for airborne operations, air logistical support, tanker forces for in-flight refueling, and assets for aeromedical evacuation.
- ✦ Provide agile combat support to enhance the air and space campaign and the deployment, employment, sustainment, and redeployment of air and space forces and other forces operating within the air and space domains, to include joint air and space bases, and for the Armed Forces other than which is organic to the individual military services and U.S. Special Operations Command in coordination with the other military services, combatant commands, and U.S. Government departments and agencies.
- ✦ Conduct global personnel recovery operations including theater-wide combat and civil search and rescue in coordination with the other military services, combatant commands, and DoD components.
- ✦ Conduct globally integrated command and control for air and space operations.

*“If we lose war in the air, we lose the war, and we lose it quickly.”*

**Field Marshal Bernard Montgomery**  
1887-1976



**For more information:** [DoD Directive 5100.1, Reference a](#)

- <https://www.esd.whs.mil/Portals/54/Documents/DD/issuances/dodd/510001p.pdf>

## AIR FORCE CORE MISSIONS

Since the birth of our service, we have trained, built, and employed the world’s most skilled Airmen, who, in various roles, support or directly conduct combat operations. Operations that Airmen are involved in also incorporate the men and women of our sister services.

At its founding on September 18, 1947, the Air Force was assigned a set of five core functions and tasked with providing those distinct capabilities to complement the roles of our sister services in a joint endeavor. Though the core missions of the Air Force have been re-designated since that time, they have not changed fundamentally. These specific missions pinpoint the Air Force’s unique role within the joint team and assure our brothers and sisters in arms that we can deliver. Joint organizations are comprised of a varied mix of service personnel, assets, and capabilities; thus, it is imperative that Airmen understand what they bring to the fight. Airmen must know that they can be counted on to deliver:

- ✦ Air Superiority
- ✦ Intelligence, Surveillance, and Reconnaissance (ISR)
- ✦ Rapid Global Mobility
- ✦ Global Strike
- ✦ Command & Control

There is no shortage of examples in our service’s storied history of what Airmen have achieved through the execution of our core missions. It is essential that they understand how these missions have been employed in concert with those of the other services and how they have contributed to Joint Force objectives.

**Air Superiority.** Control of the air domain is crucial to the success of modern and emergent warfare. For decades, combatant commanders have come to rely on the mission-essential protection that Air Superiority ensures. The opening offensive of OPERATION DESERT STORM serves well to illustrate this point. In August 1990, coalition forces launched 812 combat sorties within a 24-hour period, effectively neutralizing Iraq’s command and control capability. Within 25 days, the Iraqi Air Force halted flight operations entirely, freeing the coalition of concern over any credible enemy air attack. From the outset, Air Superiority effectively destroyed Iraq’s warfighting capability, ensuring a protected military offensive on the ground. USAF Chief of Staff, General Merrill “Tony” McPeak, asserted, “The Iraqi Air Force never recovered from the opening attack. We took the initiative at the beginning, and we held it throughout the war.”



**Intelligence, Surveillance, and Reconnaissance.** Intelligence, Surveillance, and Reconnaissance (ISR) provides situational awareness of the battlespace, allowing decision space for command elements. ISR played a crucial role in providing a holistic picture and developing a common operational graphic during OPERATION UNIFIED RESPONSE in January 2010. The operation was launched after a 7.0 magnitude earthquake struck Haiti, killing more than 316,000 people and collapsing more than 100,000 structures. During this operation, a wide array of intelligence disciplines contributed to damage assessment, identification of ports of access and travel routes, and protection of relief workers. Imagery provided from unmanned aerial vehicles and satellites, as well as open source and human intelligence gathered on the ground, helped planners determine how to get relief workers and supplies where they were needed and to ensure their safety once in country. The employment of ISR enabled ground forces to execute the operation's objectives, providing relief rapidly and effectively to survivors and saving lives.

**Rapid Global Mobility.** American power can be projected quickly to anywhere on the face of the earth because of the Air Force's capability for rapid mobility. During OPERATION JUST CAUSE, a joint operation to oust the Panamanian leader Manuel Noriega, who was wanted in the U.S. for racketeering and drug trafficking, the Air Force's rapid global reach was on display. The Air Force launched critical Joint Force elements from bases such as Charleston Air Force Base, used for personnel and supply transport, and Pope Air Force Base, used to deploy Army Rangers from the 82d Airborne Division. Overall, the Air Force employed 80 C-141, 22 C-130, and 11 C-5 aircraft which played a crucial role in OPERATION JUST CAUSE ending in just over 40 days. Rapid Global Mobility's effects safeguarded the lives of 30,000 U.S. citizens residing in Panama, protected the integrity of the Panama Canal, helped the Panamanian opposition establish genuine democracy, and brought Noriega to justice.

**Global Strike.** The Air Force demonstrated its command of Global Strike during the North Atlantic Treaty Organization's (NATO) 1995 offensive, OPERATION DELIBERATE FORCE. This three-week campaign targeted military capabilities of the Army of the Serb Republic, which had, throughout the Bosnian War, persisted in indiscriminately attacking United Nations-designated "safe zones." Partnered with 15 nations as well as ground and naval forces, U.S. aircraft flew roughly two-thirds of the operation's 3,515 sorties, hitting 97 percent of intended targets and destroying or significantly damaging 80 percent of them. After just three weeks since the dropping of the first bomb, the war's aggressors were prepared for serious negotiations. Ambassador Richard Holbrook, special negotiator to the Balkans, stated of the campaign, "without the United States Air Force and Navy and precision bombing," diplomatic efforts would not have succeeded.

**Command and Control.** Airmen employ the Air Force's other four interdependent and enduring core missions through robust, adaptable, and survivable Command and Control systems. This vital core function was evident in OPERATION ODYSSEY DAWN which offered protection to the people of Libya from attacks by its dictator, Muammar Al-Qaddafi. A complement of unique service capabilities secured mission success. While the U.S. Navy played a critical role in command and control with the placement of the USS Mount Whitney in the Mediterranean, the Air Force's employment of E-3 Airborne Warning and Control System (AWACS) and the E-8 Joint Surveillance Target Attack Radar System (JSTARS) coupled with our service's innate use of Air Operations Centers eventually brought down Al-Qaddafi and his regime.

**For more information:** [\*The Enlisted Force Structure; Global Vigilance, Global Reach, Global Power for America\*](#)

- [https://www.doctrine.af.mil/Portals/61/documents/Airman\\_Development/BrownBook.pdf](https://www.doctrine.af.mil/Portals/61/documents/Airman_Development/BrownBook.pdf)
- [https://www.af.mil/Portals/1/documents/af%20events/2015/newGV\\_GR\\_GP\\_PRINT.pdf](https://www.af.mil/Portals/1/documents/af%20events/2015/newGV_GR_GP_PRINT.pdf)

## **JOINT OPERATIONS ACROSS ALL DOMAINS**

Total Force Airmen are engaged both directly and indirectly in support of joint operations across all domains every minute of every day. Domains are those spheres of activity or influence that have common and distinct characteristics in which a force can conduct joint functions. To achieve strategic objectives, technicians in every field – air, space, cyber, security, logistics, information, administration, maintenance, etc. – play a critical role in reinforcing the Joint Force.

The Air Force's ability to operate is challenged by anti-access and area denial threats and the rapid proliferation of advanced technologies that restrict freedom of maneuver. Airmen do not fight alone, and Joint Force operations are increasingly interconnected, interdependent, and challenged. Success in this operating environment requires the convergence of effects globally and across all domains to consecutively or simultaneously present an adversary with multiple dilemmas, those situations in which one must make a difficult choice between two or more alternatives often equally undesirable.

Synergistic employment of capabilities in different domains enhances effectiveness and compensates for vulnerabilities, creating outcomes not readily attainable through single-domain action. Such dilemmas, when presented at an operational tempo that complicates or negates an adversary's response, enable the Joint Force to operate inside an adversary's decision cycle. Joint All Domain Operations (JADO) occur in air, land, maritime, cyberspace, space, and electromagnetic spectrum domains. When the Joint Force synchronizes action across multiple domains, integrated in planning and execution and at the speed needed to gain advantage, it achieves mission success.

**For more information:** [AFDP 3-99, SDP 3-99 The Department of the Air Force Role in Joint All-Domain Operations; Joint Doctrine Home](#)

- [https://www.doctrine.af.mil/Portals/61/documents/AFDP\\_3-99/AFDP%203-99%20DAF%20role%20in%20JADO.pdf](https://www.doctrine.af.mil/Portals/61/documents/AFDP_3-99/AFDP%203-99%20DAF%20role%20in%20JADO.pdf)
- <https://www.jcs.mil/Doctrine/>

## CONCLUSION

Airmen comprise an integral part of a larger team, made up of other military services, departments, and institutions of the federal government as well as allies and partners around the world. The Joint Force, through seamless integration of all components, advances national security against any and all threats to the American people and Nation's interests. Our "one fight" is our effort to deter, and if necessary, prevail in a conflict against strategic competitors. We must adapt our force design to address these and other pacing threats that challenge our Nation.

All service members must understand the importance of the Joint Force's contribution to advancing national objectives and recognize their role in fusing unique service capabilities when called upon. Jointness is not a concept; it is an agile, deliberate, and diverse integration of the strengths of all services that brings together the tools and resources needed to complement the other elements to advance our strategic objectives. Jointness is fused in military operations from the strategic to the tactical level, and each service member has a unique role within the joint mission.

*The Joint Team*, grounded in doctrine and aligned in purpose and values, assures mission success in all operations, from peacekeeping, to humanitarian need, to national security imperatives. All service members must do their part to educate and sharpen themselves, their fellow service members, and the joint partners they work alongside. The ability of the Joint Force to operate at its maximum effectiveness requires that all warfighters bring their best.

# UNITED STATES MILITARY RANKS

## Enlisted Ranks

	E-1	E-2	E-3	E-4	E-5	E-6	E-7	E-8	E-9	Special				
<b>Army</b>	Private (PV1) <i>No Insignia</i>	Private (PV2) 	Private First Class (PFC) 	Corporal (CPL) Specialist (SPC) 	Sergeant (SGT) 	Staff Sergeant (SSG) 	Sergeant First Class (SFC) 	Master Sergeant (MSG) 	First Sergeant (1SG) 	Sergeant Major (SGM) 	Command Sergeant Major (CSM) 	Sergeant Major of the Army (SMA) 	Senior Enlisted Advisor to the Chairman (SEAC) 	
<b>Marines</b>	Private (Pvt) <i>No Insignia</i>	Private First Class (PFC) 	Lance Corporal (LCpl) 	Corporal (Cpl) 	Sergeant (Sgt) 	Staff Sergeant (SSgt) 	Gunnery Sergeant (GySgt) 	Master Sergeant (MSGt) 	First Sergeant (1stSgt) 	Master Gunnery Sergeant (MGySgt) 	Sergeant Major (SgtMaj) 	Sergeant Major of the Marine Corps (SMMC) 	Senior Enlisted Advisor to the Chairman (SEAC) 	
<b>Navy</b>	Seaman Recruit (SR) <i>No Insignia</i>	Seaman Apprentice (SA) 	Seaman (SN) 	Petty Officer Third Class (PO3) 	Petty Officer Second Class (PO2) 	Petty Officer First Class (PO1) 	Chief Petty Officer (CPO) 	Senior Chief Petty Officer (SCPO) 	Command Senior Chief Petty Officer (CMDSCS) 	Master Chief Petty Officer (MCPO) 	Command Master Chief Petty Officer (CMDCM) 	Force/Fleet Master Chief Petty Officer (FORMC/FLTMCM) 	Master Chief Petty Officer of the Navy (MCPON) 	Senior Enlisted Advisor to the Chairman (SEAC) 
<b>Air Force</b>	Airman Basic (AB) <i>No Insignia</i>	Airman (Amm) 	Airman First Class (A1C) 	Senior Airman (SrA) 	Staff Sergeant (SSgt) 	Technical Sergeant (TSgt) 	Master Sergeant (MSgt) 	First Sergeant (1stSgt) 	Senior Master Sergeant (SMSgt) 	Chief Master Sergeant (CMSgt) 	First Sergeant (CMSgt) 	Command Chief Master Sergeant (CCM) 	Chief Master Sergeant of the Air Force (CMSAF) 	Senior Enlisted Advisor to the Chairman (SEAC) 
<b>Space Force</b>	Specialist 1 (Spec 1) <i>No Insignia</i>	Specialist 2 (Spec 2) 	Specialist 3 (Spec 3) 	Specialist 4 (Spec 4) 	Sergeant (Sgt) 	Technical Sergeant (TSgt) 	Master Sergeant (MSgt) 	Senior Master Sergeant (SMSgt) 	Chief Master Sergeant (CMSgt) 	Chief Master Sergeant of the Space Force (CMSSF) 	Senior Enlisted Advisor to the Chairman (SEAC) <i>No Insignia</i>			
<b>Coast Guard</b>	Seaman Recruit (SR) 	Seaman Apprentice (SA) 	Seaman (SN) 	Petty Officer Third Class (PO3) 	Petty Officer Second Class (PO2) 	Petty Officer First Class (PO1) 	Chief Petty Officer (CPO) 	Senior Chief Petty Officer (SCPO) 	Master Chief Petty Officer (MCPO) 	Fleet/Command Master Chief (CMC) 	Master Chief Petty Officer of the Coast Guard (MCPOCG) 			

## Officer Ranks

	O-1	O-2	O-3	O-4	O-5	O-6	O-7	O-8	O-9	O-10	Special
<b>Army</b>	Second Lieutenant (2LT) 	First Lieutenant (1LT) 	Captain (CPT) 	Major (MAJ) 	Lieutenant Colonel (LTC) 	Colonel (COL) 	Brigadier General (BG) 	Major General (MG) 	Lieutenant General (LTG) 	General (GEN) 	General of the Army (GA) 
<b>Marines</b>	Second Lieutenant (2nd Lt) 	First Lieutenant (1st Lt) 	Captain (Capt) 	Major (Maj) 	Lieutenant Colonel (Lt Col) 	Colonel (Col) 	Brigadier General (BGen) 	Major General (Maj Gen) 	Lieutenant General (Lt Gen) 	General (Gen) 	Not Used
<b>Navy</b>	Ensign (ENS) 	Lieutenant Junior Grade (LTJG) 	Lieutenant (LT) 	Lieutenant Commander (LCDR) 	Commander (CDR) 	Captain (CAPT) 	Rear Admiral (RDML) 	Rear Admiral (RADM) 	Vice Admiral (VADM) 	Admiral (ADM) 	Fleet Admiral (FADM) 
<b>Air Force</b>	Second Lieutenant (2d Lt) 	First Lieutenant (1st Lt) 	Captain (Capt) 	Major (Maj) 	Lieutenant Colonel (Lt Col) 	Colonel (Col) 	Brigadier General (Brig Gen) 	Major General (Maj Gen) 	Lieutenant General (Lt Gen) 	General (Gen) 	General of the Air Force (GAF) 
<b>Space Force</b>	Second Lieutenant (2d Lt) 	First Lieutenant (1st Lt) 	Captain (Capt) 	Major (Maj) 	Lieutenant Colonel (Lt Col) 	Colonel (Col) 	Brigadier General (Brig Gen) 	Major General (Maj Gen) 	Lieutenant General (Lt Gen) 	General (Gen) 	Not Used
<b>Coast Guard</b>	Ensign (ENS) 	Lieutenant Junior Grade (LTJG) 	Lieutenant (LT) 	Lieutenant Commander (LCDR) 	Commander (CDR) 	Captain (CAPT) 	Rear Admiral (RDML) 	Rear Admiral (RADM) 	Vice Admiral (VADM) 	Admiral (ADM) 	Not Used

## Warrant Officer Ranks

Army					Navy				
W-1	W-2	W-3	W-4	W-5	W-1	W-2	W-3	W-4	W-5
Warrant Officer (WO1) 	Chief Warrant Officer (CWO2) 	Chief Warrant Officer (CWO3) 	Chief Warrant Officer (CWO4) 	Chief Warrant Officer (CWO5) 	Warrant Officer (WO1) 	Chief Warrant Officer (CWO2) 	Chief Warrant Officer (CWO3) 	Chief Warrant Officer (CWO4) 	Chief Warrant Officer (CWO5) 
Marines					Coast Guard				
W-1	W-2	W-3	W-4	W-5	W-1	W-2	W-3	W-4	W-5
Warrant Officer (WO) 	Chief Warrant Officer (CWO2) 	Chief Warrant Officer (CWO3) 	Chief Warrant Officer (CWO4) 	Chief Warrant Officer (CWO5) 	Not Used	Chief Warrant Officer (CWO2) 	Chief Warrant Officer (CWO3) 	Chief Warrant Officer (CWO4) 	Not Used
Air Force					Space Force				
Not Used					Not Used				

## REFERENCES

[AFDP 3-99, SDP 3-99, The Department of the Air Force Role in Joint All-Domain Operations](#) 19 November 2021

[The Combined Joint Task Forces Concept](#) Accessed June 2022

[Department of Defense Reorganization Act of 1958](#) 6 August 1958

[DoD Dictionary of Military and Associated Terms](#) August 2022

[DoD Directive 5100.1, Reference a](#) 21 December 2010

[The Enlisted Force Structure](#) 16 May 2022

[Executive Orders | National Archives](#) 5 March 2003

[The First Gulf War](#) Accessed June 2022

[Global Vigilance, Global Reach, Global Power for America](#) March-April 2014

[Guidance on Fostering Professionalism within the Department of Defense](#) 12 February 2015

[H.R.3622 - Goldwater-Nichols Department of Defense Reorganization Act of 1986](#) 1 October 1986

[Joint Doctrine Home](#) Accessed June 2022

[The Joint Staff](#) Accessed June 2022

[JP 1, Doctrine for the Armed Forces of the United States](#) 25 March 2013

[JP 3-0, Joint Campaigns and Operations](#) 18 June 2022

[JP 3-30, Joint Air Operations](#) 17 September 2021

[JP 3-33, Joint Task Force Headquarters](#) 31 January 2018

[JP 5-0, Joint Planning](#) 1 December 2020

[National Security Act of 1947](#) 26 July 1947

[The Noncommissioned Officer and Petty Officer](#) 2014, National Defense University Press

[Title 10, U.S. Code](#) 10 August 1956



**U.S. AIR FORCE**